

Modelling of indirect evaporative air coolers

P. J. ERENS and A. A. DREYER

Department of Mechanical Engineering, University of Stellenbosch, Stellenbosch 7600,
South Africa

(Received 3 September 1991)

Abstract—The modelling of indirect evaporative air coolers is discussed and three calculation models are described. Sample calculations show that the optimum shape of the cooler unit would result in a primary to secondary air velocity ratio of about 1.4, assuming that the primary and the secondary air mass flow rates are the same and that the same plate spacings are used on the primary and secondary sides. In conclusion it is found that the simplified model gives good results and is recommended for the evaluation of smaller systems and for initial design purposes while the more sophisticated methods should be used for more accurate performance prediction.

1. INTRODUCTION

THE USE of evaporative cooling for air conditioning has been considered as a cost saving alternative for decades. The simplest evaporative air conditioning system consists of an air supply duct incorporating a water spray system (or a wetted evaporative cooler pad). In such a system (see Fig. 1(a)) the air stream would evaporate a part of the water and this would lower the air dry bulb temperature and increase the air humidity ratio (absolute).

In many applications the increase in the supply air humidity ratio is not desirable and in this case an indirect evaporative cooling system can be employed. Direct evaporative cooling systems employing a recirculating water spray system could also pose a health threat. Figure 1(b) shows a typical indirect evaporative cooling system where the air stream which has been cooled by the evaporating water spray is used to cool the primary (dry) room supply air. The primary air humidity ratio does not increase since it is never in direct contact with the water (or wetted air stream).

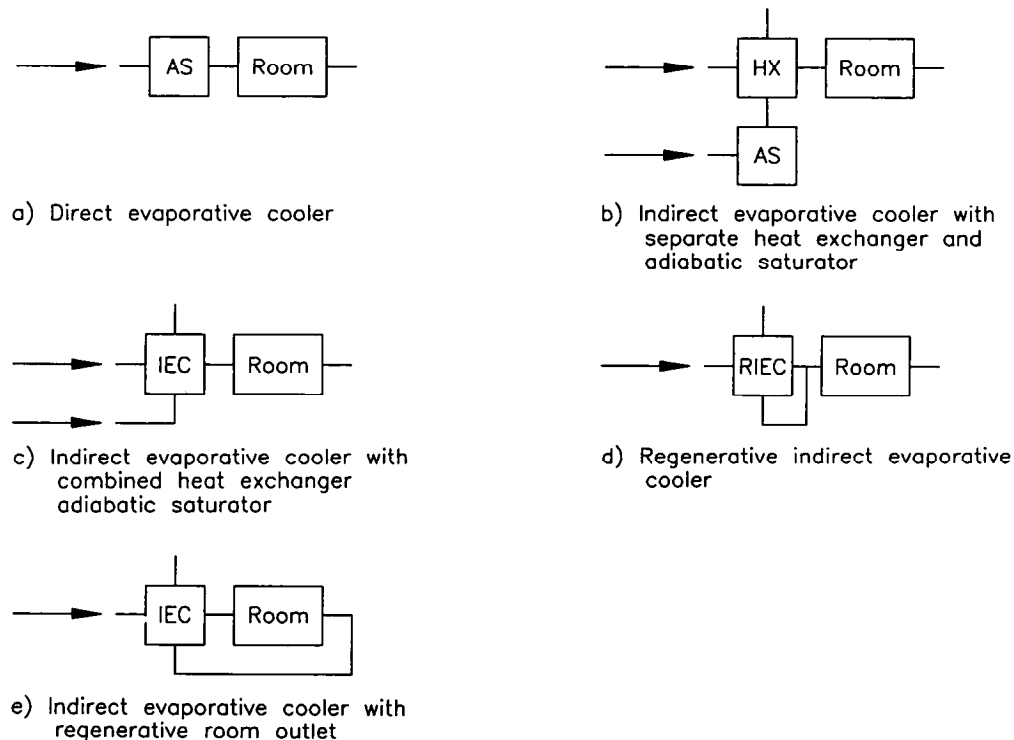

FIG. 1. Evaporative air conditioning system configurations.

NOMENCLATURE

A	area [m^2]	η_1, η_2	efficiency, defined by equations (22) and (23)
a	effective surface area per unit volume [$\text{m}^2 \text{m}^{-3}$]	μ	dynamic viscosity [$\text{kg m}^{-1} \text{s}^{-1}$]
c_p	specific heat at constant pressure [$\text{J kg}^{-1} \text{K}^{-1}$]	ν	kinematic viscosity [$\text{m}^2 \text{s}^{-1}$]
g	gravitational acceleration [m s^{-2}]	ρ	density [kg m^{-3}].
h	heat transfer coefficient [$\text{W m}^{-2} \text{K}^{-1}$]	Subscripts	
h_D	mass transfer coefficient [$\text{kg m}^{-2} \text{s}^{-1}$]	a	air (wet side)
h_w	film heat transfer coefficient [$\text{W m}^{-2} \text{K}^{-1}$]	as	saturated air
i	enthalpy [J kg^{-1}]	asw	air saturated at bulk recirculating water temperature
k	thermal conductivity [$\text{W m}^{-1} \text{K}^{-1}$]	c	convective or convection
Le	Lewis number	db	dry bulb
Le_r	Lewis factor	f	film or fouling
m	mass flow rate [kg s^{-1}]	i	inlet or inside
NTU	number of transfer units	m	moist
Re	Reynolds number	o	outlet or outside
Re_r	film Reynolds number, $4\Gamma/\mu$	p	process fluid (dry side air) or plate
t	thickness [m]	v	vapour
T	temperature [$^{\circ}\text{C}$]	w	water (recirculating)
U	overall heat transfer coefficient [$\text{W m}^{-2} \text{K}^{-1}$]	wb	wet bulb.
v	velocity [m s^{-1}]	Abbreviations	
w	humidity ratio [$\text{kg water (kg dry air)}^{-1}$].	AS	adiabatic saturator (spray chamber)
Greek symbols		DEC	direct evaporative cooler
Γ	water mass flow rate per unit length [$\text{kg m}^{-1} \text{s}^{-1}$]	IEC	indirect evaporative cooler
		RIEC	regenerative indirect evaporative cooler.

It is possible to combine the spray chamber and the heat exchanger into one unit as shown in Fig. 1(c) to form an indirect evaporative air cooler. This paper deals with the modelling of such a cooler.

Referring to Fig. 1(c) and the schematic psychrometric chart in Fig. 2 it will be noted that the air leaving the dry side of the cooler has a lower wet bulb temperature than the ambient. Consequently, it would

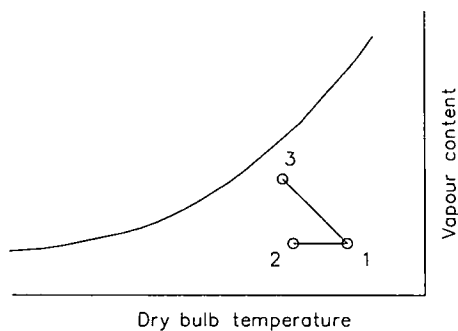

FIG. 2. Psychrometric chart showing the condition of the ambient air (1), the air leaving the dry side (2) and the air leaving the wet side (3) of the evaporative cooler.

be advantageous to pass a fraction of this cooled dry side air through the wet side of the heat exchanger instead of using ambient air (Fig. 1(d)). This type of cooler is referred to as a regenerative indirect evaporative cooler. If the room outlet temperature has a lower wet bulb than ambient it could be used on the wet side instead of using a fraction of the cooled dry side air or ambient air (Fig. 1(e)).

If regenerative evaporative cooler units (as shown in Fig. 1(d)) were placed in series, the cooled air leaving the last unit would approach the prevailing ambient dew point temperature, but each additional stage would lower the dry side air mass flow rate.

Various investigations studied the relative merits of indirect evaporative and regenerative evaporative cooling including Brace [1], Anonymous [2], Watt and Bacon [3], Eskra [4], Supple [5], Uys [6], Claassen [7] and Datta *et al.* [8].

Pescod [9] proposed a simple design method for an indirect evaporative cooler using parallel plastic plates with small protrusions. Although the thermal conductivity of plastic is very low, the heat transfer resistance across a thin plastic plate would be less than the dry side air/plate thermal resistance.

Maclaine-Cross and Banks [10] presented an

approximate model for the analysis of indirect evaporative coolers. They assumed that (i) the water film is stationary and continuously replenished with water at the same temperature and (ii) the saturation line can be expressed as a linear function of temperature in the operating range. These assumptions enabled the decoupling of the equations describing the wet side and the dry side of the cooler. The governing equations were solved by defining a new independent variable: the difference between dry bulb and wet bulb temperatures. This model could then be used to predict the cooler performance by analogy to dry surface heat exchangers.

Kettleborough and Hsieh [11, 12] described a counterflow indirect evaporative cooler unit where the secondary (wet side) air and the water flow in parallel downwards and the primary (dry side) air flows upwards through the cooler. By using a simple wettability factor the effect of incomplete wetting could be estimated.

Singh and Narayankhedkar [13] report on experimental work carried out on a cross-flow plastic plate indirect evaporative cooler with co-current (downwards) water and air flow on the wet side. For a unit with a plate spacing of between 3 and 4 mm it was found that a water spray density of $2800 \text{ kg m}^{-2} \text{ h}^{-1}$ and a free stream air velocity of about 1.4 m s^{-1} approaching the wet side of the cooler represent the optimum trade-off between cooling effect and cost.

Hsu and Lavan [14] used an iterative, column-row, successive, over-relaxation technique to solve the governing equations in a cross-flow parallel plate regenerative indirect evaporative cooler. They assumed the water to be locally replenished and that the water layer is negligibly thin (no heat transfer resistance). The local water temperature was calculated from the mass and energy balance equations, i.e. the water was not circulating. The given definition of effectivity results in efficiencies of larger than unity when analysing a cooler employing regeneration

(extraction). The definition of efficiency as given by Pescod [9] is preferred.

An indirect evaporative air cooler is the same as a closed circuit evaporative process fluid cooler with dry side air as the process fluid. Closed circuit coolers and condensers have been analysed by various researchers with varying degrees of accuracy. Theoretical models were presented by Parker and Treybal [15], Mizushima *et al.* [16], Leidenfrost and Korenic [17, 18], Erens and Dreyer [19, 20].

2. MATHEMATICAL MODELLING

It is assumed that the evaporative cooler unit consists of a series of parallel plates with every second slot open for the dry side air flow (in the horizontal plane) and every other slot open for the secondary side air and the recirculating water flows (in the vertical plane). Two modelling approaches can be followed in the analysis of evaporative coolers. When using the first approach, the cooler which is to be evaluated is divided into small elements (see Fig. 3). In this study these elements are chosen as an imaginary volume containing a section of plate, surface area dA_0 , covered by a water layer on one side. The air flowing on the dry side and the wet sides are referred to as the primary side and secondary air flows, respectively. Three energy streams influence each element, i.e. (i) the warm primary side air; (ii) gravity-driven water flowing over one side of the plate; and (iii) the secondary air stream flowing across the wetted surface. The governing differential equations for a typical element can then be integrated numerically in order to find the outlet conditions of a given element if the inlet conditions are known. Through a method of successive calculations, each element in the cooler is evaluated and the outlet conditions for the two air streams are found. In the second approach, the whole cooler is considered as a single element (see Fig. 4) and after making the necessary assumptions, the con-

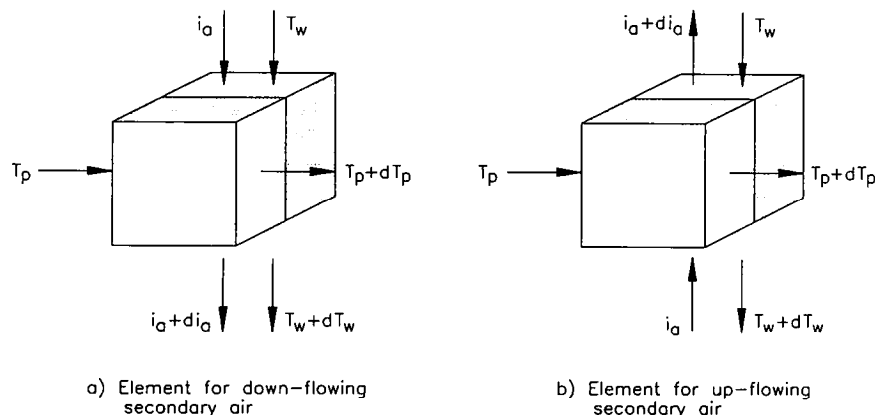

FIG. 3. Elements for the mathematical modelling of an evaporative cooler.

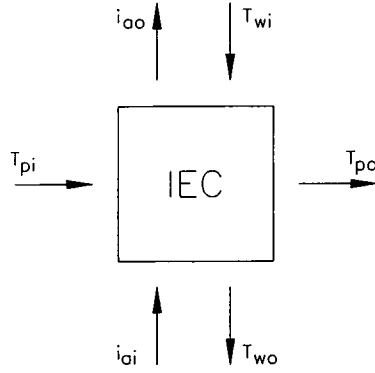

FIG. 4. Cooler layout for the simplified model.

trolling differential equations can be integrated analytically, resulting in a fairly simple-to-use model.

The main assumptions are that: (i) the recirculating water is evenly distributed over the plate surface; (ii) the cooler is in a steady state; and (iii) the air/water interface area is approximately equal to the plate area.

2.1. Poppe model

This model is based on the models proposed by Bourillot [21] and Poppe and Rögner [22] for the analysis of direct contact wet cooling towers, but the equations presented here contain additional terms relating to the heat transfer between the primary air stream and the water film on the outside of the plate.

Consider the typical elements of a typical evaporative cooler shown in Fig. 3. The sign convention used results in the same set of governing equations if the water and secondary air flows are in the same direction (downwards) and when they are in opposite directions. From the mass and energy balances of a typical element it follows that

$$dw_w = -dm_w/m_a \quad (1)$$

$$dT_w = (-m_a di_a - c_{pw} T_w dm_w - m_p c_{pp} dT_p) / m_w c_{pw}. \quad (2)$$

If the air entering an element is not saturated, the mass flow rate of water evaporating into the air is given by

$$dm_w = -h_D (w_{asw} - w_a) dA_o \quad (3)$$

and the change in air enthalpy due to simultaneous heat and mass transfer can be expressed as

$$di_a = \frac{h_D dA_o}{m_a} [(i_{asw} - i_a) + (Le_f - 1)[(i_{asw} - i_a) - (w_{asw} - w_a)i_v]]. \quad (4)$$

If the air entering the element is saturated or over-saturated, equations (3) and (4) can be rewritten as

$$dm_w = -h_D (w_{asw} - w_{as}) dA_o \quad (5)$$

and

$$di_a = \frac{h_D dA_o}{m_a} [(i_{asw} - i_a) + (Le_f - 1)[(i_{asw} - i_a) - (w_{asw} - w_{as})i_v] + Le_f (w_a - w_{as}) c_{pw} T_w]. \quad (6)$$

The primary air temperature change in an element can be expressed by

$$dT_p = -\frac{U_o dA_o}{m_p c_{pp}} (T_p - T_w) \quad (7)$$

with

$$U_o = \left(\frac{1}{h_p} + \frac{t_p}{k_p} + \frac{1}{h_w} \right)^{-1}. \quad (8)$$

In the case of under-saturated inlet air, the element is fully modelled by equations (1)–(4) and (7), while equations (1), (2) and (5)–(7) describe the element completely if the inlet air is saturated or over-saturated. The dimensionless group, $(h_c/h_D c_{pm})$, is known as the Lewis factor or Lewis ratio, Le_f . According to Bosnjakovic [23], the Lewis ratio can be expressed as

$$Le_f = (Le^{2/3}) \frac{\left(\frac{0.622 + w_{asw}}{0.622 + w_a} \right)}{\ln \left(\frac{0.622 + w_{asw}}{0.622 + w_a} \right)}. \quad (9)$$

2.2. Merkel model

The Merkel-type governing equations can be derived from the Poppe model by assuming a Lewis factor of unity and negligible water evaporation rate. The Merkel model does not involve different equations if the air is saturated, implying that the air never becomes over-saturated. This model is fully described by the following equations

$$dT_w = (-m_a di_a - m_p c_{pp} dT_p) / (m_w c_{pw}) \quad (10)$$

$$dT_p = -U_o (T_p - T_w) dA_o / (m_p c_{pp}) \quad (11)$$

$$di_a = h_D dA_o (i_{asw} - i_a) / m_a. \quad (12)$$

2.3. Simplified model

Since the water flowing through the cooler is normally recirculated, the inlet temperature and the outlet temperature of the water must be the same (assuming that the make-up water is supplied at the sump temperature). By assuming that the recirculating water temperature is constant, at T_{wm} , throughout the cooler, the cooler performance can be obtained by integrating equations (11) and (12) to give

$$A_o = \frac{m_a}{h_D} \ln \left(\frac{i_{asw} - i_{ai}}{i_{asw} - i_{ao}} \right) \quad (13)$$

and

$$A_o = \frac{m_p c_{pp}}{U_o} \ln \left(\frac{T_{pi} - T_{wm}}{T_{po} - T_{wm}} \right). \quad (14)$$

By finding the value of T_{wm} (note that $i_{asw} = i_{as}(T_{wm})$) which satisfies these relations simultaneously, the required cooler area, for a specified load, can be determined. This procedure could be used iteratively for rating calculations as well but the rating procedure is greatly simplified as follows: from equations (13) and (14) it can be shown that

$$T_{po} = T_{wm} + (T_{pi} - T_{wm}) e^{-NTU_p} \quad (15)$$

and

$$i_{ao} = i_{asw} - (i_{asw} - i_{ai}) e^{-NTU_a} \quad (16)$$

with $NTU_p = A_o U_o / m_p c_{pp}$ and $NTU_a = A_o h_D / m_a$.

Substituting equations (15) and (16) into the energy balance equation, $m_a(i_{ao} - i_{ai}) = m_p c_{pp}(T_{pi} - T_{po})$, it follows that

$$T_{wm} = T_{pi} - \frac{m_a(i_{asw} - i_{ai})(1 - e^{-NTU_a})}{m_p c_{pp}(1 - e^{-NTU_p})}. \quad (17)$$

The rating of an evaporative cooler can now be done as follows: a value of T_{wm} is chosen and by employing equation (17) this value is corrected iteratively until the value of T_{wm} satisfies it. This value of T_{wm} can now be used to determine the outlet conditions of the cooler from equations (15) and (16).

3. GOVERNING HEAT AND MASS TRANSFER COEFFICIENTS

Plastic (PVC) would be the ideal material for the plates as far as cost, weight and corrosion resistance are concerned. Although plastics have very low thermal conductivities, the thermal resistance of thin plastic plates becomes relatively small in comparison with the thermal resistance of the dry side and the air/water interface. The air/water interface represents the governing resistance to heat transfer. The thermal resistance of the water film is negligibly small in comparison with the air/water interface thermal resistance.

The mass transfer coefficient can be approximated using the analogy between heat and mass transfer so that

$$h_D = \frac{h_c}{c_{pm} Le_f} \quad (18)$$

where h_c is defined as the dry heat transfer coefficient calculated with any relevant correlation for flow between parallel plates. For parallel plates with protrusions, the heat transfer coefficient can be calculated using the results presented by Pescod [24].

If the water mass flow rates become larger, the water velocity at the interface increases and the Reynolds number for air flow should be based on the relative velocity of the air stream and the water film surface velocity and the actual dimensions of the air flow passage between the wetted plates.

For steady, fully developed, two-dimensional flow of a laminar film along a vertical surface, in the

absence of gas shear, it follows that

$$v_f = 1.5(vg/48)^{1/3} (Re_f)^{2/3} \quad (19)$$

and

$$t_f = (3v^2/4g)^{1/3} (Re_f)^{1/3}. \quad (20)$$

The water side film heat transfer coefficient can be expressed as

$$h_w = \frac{k_w}{t_f}. \quad (21)$$

4. NUMERICAL INTEGRATION PROCEDURE

The Poppe and Merkel models both consist of sets of coupled ordinary differential equations which can be solved simultaneously, using a 4th-order Runge-Kutta integration procedure. Erens and Dreyer [19, 20] found that the extra effort and computer time required in using the Poppe model for the simulation of evaporative fluid coolers and condensers is not justified by the small improvement in accuracy over the Merkel model. The governing mass transfer coefficient calculated from the analogy between heat and mass transfer represents an uncertainty which largely outweighs the improved accuracy of the Poppe model.

The integration procedure starts at the secondary (wet side) air inlet side and proceeds through the whole cooler evaluating every element, with the outlet conditions for one element being the inlet conditions for the next element. In the operation of indirect evaporative coolers the water is normally recirculated, which means that the inlet and outlet recirculating water temperature must be equal at the operating point of the cooler. This temperature has to be found iteratively.

For the parallel flow case both the water and the secondary (wet side) air flow vertically downwards. The integration procedure starts at the top where the inlet air conditions are known (if no regeneration is used) and the assumed water inlet temperature is known. The integration proceeds downwards to the secondary air outlet side. The average water outlet temperature must be equal to the water inlet temperature. If this is not the case, another inlet water temperature is assumed until the solution converges.

In the case of a counterflow layout, the water flows vertically downwards and the secondary (wet side) air flows from the bottom upwards. The counterflow case is slightly more complicated since the water outlet temperature at the secondary (wet side) air inlet side is not constant along the bottom length of the cooler. The water outlet temperature is assumed and the integration process proceeds upwards until the inlet water temperatures are found for each element along the length of the cooler. The differences between the inlet and outlet water temperatures in each vertical column of elements is used to update the assumed water outlet temperature (at the secondary air inlet side). The iter-

ative process stops when the average inlet and outlet recirculating water temperatures are the same and when the calculated inlet water temperature (at the secondary air outlet side) is constant along the length of the cooler.

5. DISCUSSION

Table 1 shows the predictions of the successive calculation model and the simplified models for various indirect evaporative cooler sizes. For the larger evaporative cooler units, the simplified model is less accurate due to the assumption of a constant recirculating water temperature.

Typical computer execution times on an 80386-based IBM compatible computer with a math co-processor were:

Simplified model	<0.01 s
Merkel model (wet side parallel flow)	14.0 s†
Merkel model (wet side counterflow)	66.4 s†

Figures 5 and 6 show typical temperature and enthalpy profiles through a non-regenerative cross-flow evaporative cooler with up-flowing and down-flowing secondary air, respectively. The recirculating water temperature increases at the primary air inlet side and decreases at the primary air outlet side. From both Figs. 5 and 6 it can be noted that the recirculating water temperature varies very little and consequently the simplified model assumption of a constant recirculating water temperature is justified.

The efficiency of an evaporative cooler unit was defined by Pescod [9] as

$$\eta_1 = \left(\frac{T_{pidb} - T_{podb}}{T_{pidb} - T_{aiwb}} \right). \quad (22)$$

If a series of regenerative evaporative coolers were used, the theoretical lowest obtainable air temperature would be the dewpoint temperature corresponding to the ambient air conditions. With this in mind, the efficiency can also be defined as

$$\eta_2 = \left(\frac{T_{pidb} - T_{podb}}{T_{pidb} - T_{dewpoint}} \right). \quad (23)$$

Figure 7 shows the efficiencies of a regenerative (RIEC) (with 50% of primary air passing through the wet side) and a non-regenerative (IEC) indirect evaporative cooler as a function of primary side free stream velocity. From Fig. 7 it can be seen that the regenerative evaporative cooler has a lower efficiency than the non-regenerative unit when the efficiency as defined by equation (22) is used. When using equation (23) to define the efficiency, the regenerative unit has a slightly higher efficiency than the non-regenerative unit.

Figure 8 shows the variation of the efficiencies with

Table 1. Cooler capacity predictions

Cooler volume (m ³)	Simplified model (kW)	Merkel model (parallel flow) (kW)	Merkel model (counterflow) (kW)
0.25	0.44	0.44	0.44
0.5	2.26	2.33	2.32
0.75	5.43	5.68	5.65
1.0	9.81	10.48	10.33

the fraction of cooled primary air passed through the wet side of the cooler unit in a regenerative evaporative cooler. If a large fraction of the cooled primary air is passed through the wet side of the cooler, it would give a very high efficiency but the capacity of the unit would be very low since only a small fraction of the cooled air would be supplied to the room. Figure 9 shows the variation of cooling capacity with the fraction of cooled primary side air which is passed through the wet side. It can be noted that the optimum fraction is a function of plate spacing.

The shape of the plastic plate evaporative cooler can be optimized to maximize the cooling capacity while minimizing the total pressure drop (dry and wet sides). For this comparison, an indirect evaporative cooler linked to a room (as shown in Fig. 1(e)) was considered. The following conditions were assumed:

cooler volume	1.0 m ³
ambient dry bulb temperature	25.0°C
ambient wet bulb temperature	19.5°C
required room temperature	24.0°C
room load	8.0 kW.

The shape of the cooler unit was varied by considering different primary side inlet heights (see Fig. 10) while keeping the volume constant. It was assumed the cooler width and cooler length were equal in all cases and that the wet and dry side plate spacings were identical. The effect of the water film on the pressure drop through the wet side was ignored. For each shape, the required primary air mass flow rate to give the required room dry bulb temperature is calculated iteratively. It was assumed that the secondary air mass flow rate is the same as the primary air mass flow rate. The variation of the ratio of cooling capacity and required fan power with the cooler height is shown in Fig. 11. The steps in the curves for the 4 and 5 mm plate spacings are due to the air flow in either the primary or-secondary side changing from laminar to turbulent. The optimum cooler height seems to be around 800 mm, which results in a secondary to primary side area ratio of 1.4. It can also be noted that the unit with the 3 mm plate spacing shows the highest cooling capacity for a given required fan power.

6. CONCLUSIONS

In most cases, the simplified model for the evaluation of an indirect evaporative cooler as described

† Cooler divided into 400 elements.

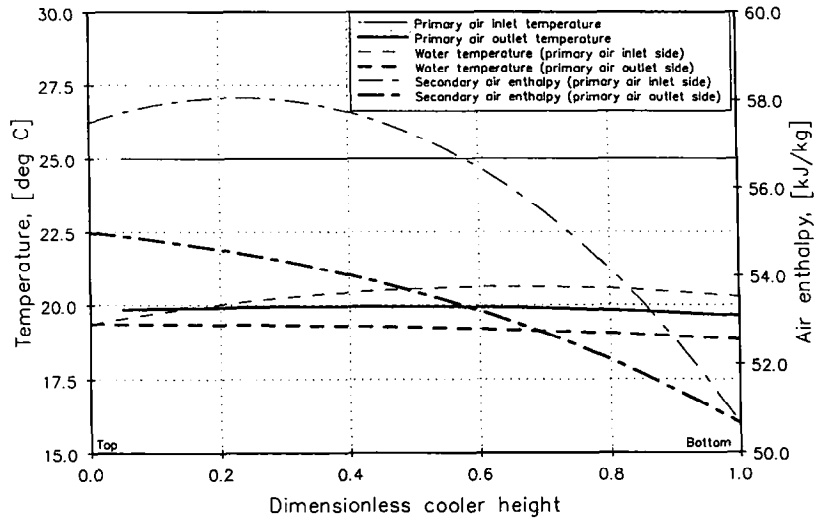

FIG. 5. Temperature and enthalpy profiles along the height of an evaporative cooler with up-flowing secondary air.

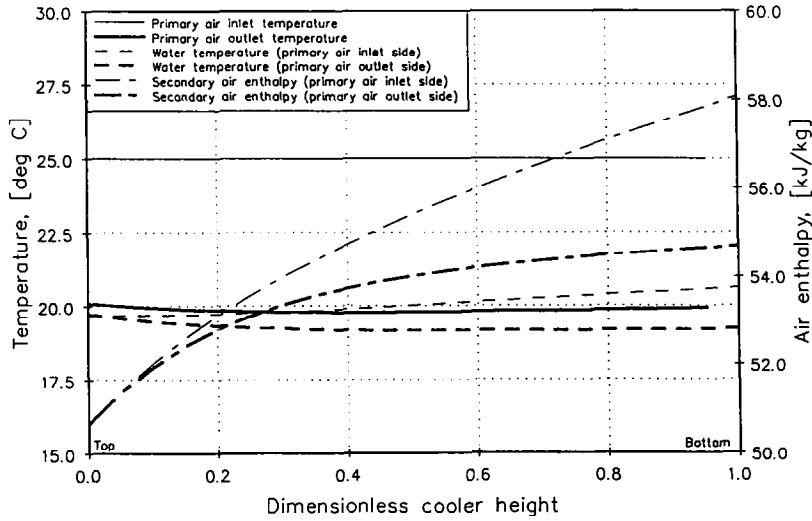

FIG. 6. Temperature and enthalpy profiles along the height of an evaporative cooler with down-flowing secondary air.

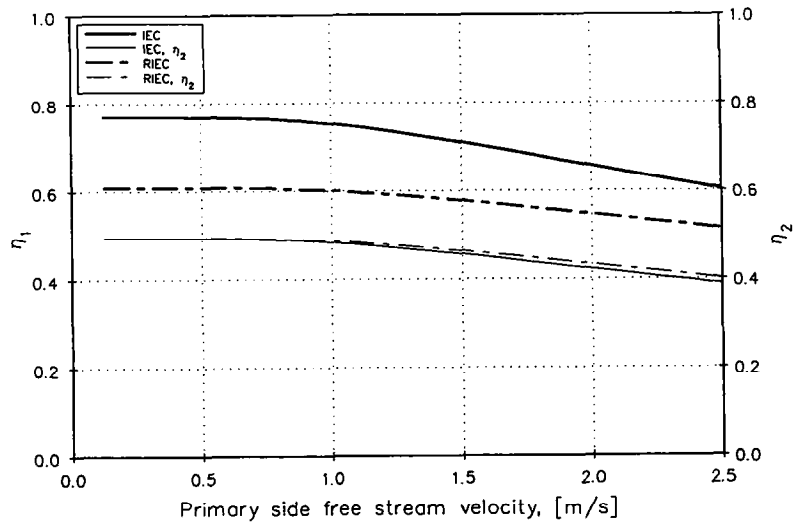

FIG. 7. Efficiencies of a regenerative (with 50% of the cooled primary side air passing through the secondary side) and a non-regenerative evaporative cooler.

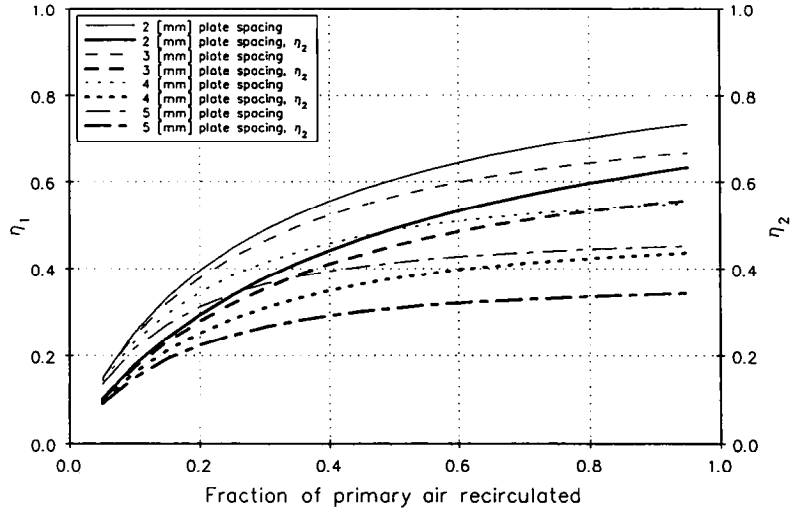

FIG. 8. Variation of efficiency of a regenerative evaporative cooler with the fraction of cooled primary side air passing through the secondary side.

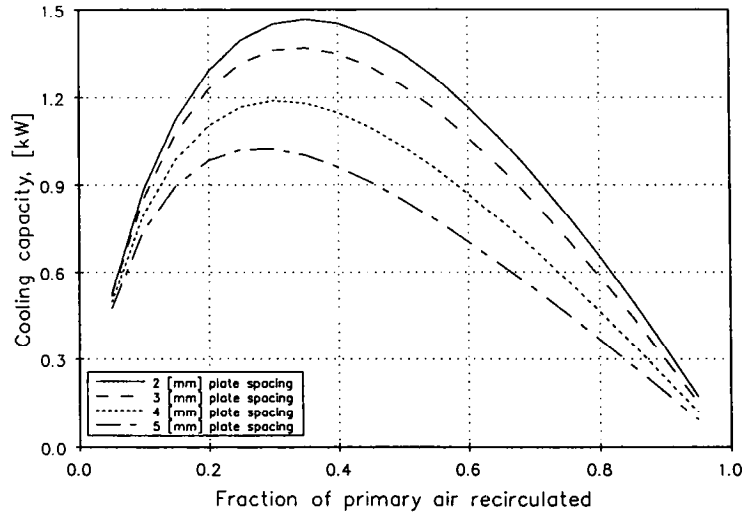

FIG. 9. Variation in cooling capacity of a regenerative evaporative cooler with the fraction of cooled primary side air passing through the secondary side.

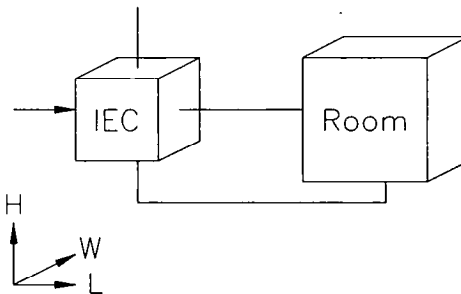

FIG. 10. Typical evaporative air conditioning system layout.

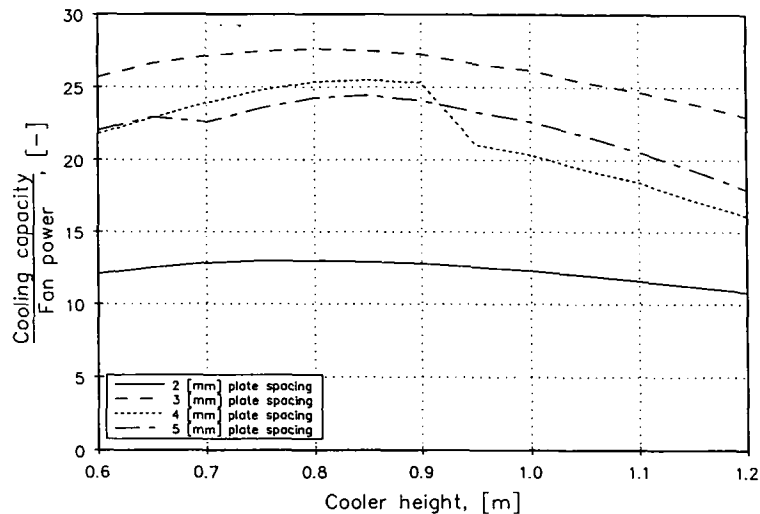

FIG. 11. Coefficient of performance of an evaporative air conditioning system.

above, would yield results which are accurate enough for design purposes.

The definition of efficiency as a function of dew-point temperature, equation (23), should be used if regenerative evaporative coolers are employed.

The optimum fraction of cooled primary air flowing through the wet side of a regenerative indirect evaporative cooler is dependent on the plate spacing. For a regenerative evaporative cooler with plates spaced 3 mm apart, the optimum cooling capacity is found if 36% of the cooled primary air is passed through the wet side.

The shape of the cooler is also an important variable in maximizing the cooling effect and minimizing the required fan power. The maximum cooling effect for the smallest total required fan power for an arbitrary indirect evaporative cooler linked to a room, was obtained with a plate spacing of 3 mm and a secondary to primary side area ratio of 1.4.

Acknowledgement—We gratefully acknowledge the financial support given to this program by the National Energy Council.

REFERENCES

1. K. P. Brace, Regenerative cooling for hot dry climates, *Heat Vent.* **29**, 36–37 (1932).
2. Anonymous, 100% outside air for Dallas apartments, *Heat. Vent.* **35**, 37–38 (1938).
3. J. R. Watt and R. A. Bacon, The indirect evaporative air cooler, *Trans. ASHRAE* **62**, 553–562 (1956).
4. N. Eskra, Indirect/direct evaporative cooling systems, *ASHRAE J.* **22**, 21–25 (1980).
5. R. G. Supple, Evaporative cooling for comfort, *ASHRAE J.* **24**, 36–42 (1982).
6. K. Uys, Meerstadia direkte/indirekte verdampingsverkoelingsstelsels vir lugversorgingsinstallasies, *S.A. Mech. Engr* **37**, 264–267 (1987); *S.A. Mech. Engr* **38**, 6–7 (1988).
7. C. J. Claassen, Multi-stage evaporative cooling, *S.A. Refrig. Aircond.* **3**, 36–40 (1987).
8. S. Datta, P. N. Sahgal, S. Subrahmaniam, S. C. Dhingra and V. V. N. Kishore, Design and operating characteristics of evaporative cooling systems, *Int. J. Refrig.* **10**, 205–208 (1987).
9. D. Pescod, A heat exchanger for energy saving in an air-conditioning plant, *Trans. ASHRAE* **85**, 238–251 (1979).
10. I. L. Maclaine-Cross and P. J. Banks, A general theory of wet surface heat exchangers and its application to regenerative evaporative cooling, *J. Heat Transfer* **103**, 579–585 (1983).
11. C. F. Kettleborough and C. S. Hsieh, The thermal performance of the wet plastic plate heat exchanger used as an indirect evaporative cooler, ASME Paper 81-WA/Sol-11 (1981).
12. C. F. Kettleborough and C. S. Hsieh, The thermal performance of the wet plastic plate heat exchanger used as an indirect evaporative cooler, *J. Heat Transfer* **105**, 366–373 (1983).
13. M. Singh and K. G. Narayankhedkar, Investigation and development of indirect evaporative cooler using plastic heat exchanger, *Mech. Engng Bull.* **13**, 61–65 (1982).
14. S. T. Hsu and Z. Lavan, Optimization of wet-surface heat exchangers, *Energy* **14**, 757–770 (1989).
15. R. O. Parker and R. E. Treybal, The heat, mass transfer characteristics of evaporative coolers, *Chem. Engng Prog. Symp. Ser.* **57**, 138–149 (1961).
16. T. Mizushima, R. Ito and H. Miyashita, Characteristics and methods of thermal design of evaporative coolers, *Int. Chem. Engng* **8**, 532–538 (1968).
17. W. Leidenfrost and B. Korenic, Analysis of evaporative cooling and enhancement of condenser efficiency and of coefficient of performance, *Wärme- und Stoffübertrag.* **12**, 5–23 (1979).
18. W. Leidenfrost and B. Korenic, Evaporative cooling and heat transfer augmentation related to reduced condenser temperatures, *Heat Transfer Engng* **3**, 38–59 (1982).
19. P. J. Erens and A. A. Dreyer, An improved procedure for calculating the performance of evaporative closed circuit coolers, *A.I.Ch.E. Symp. Ser.* **84**, 140–145 (1988).
20. A. A. Dreyer and P. J. Erens, Heat and mass transfer coefficient and pressure drop correlations for a crossflow evaporative cooler, ASME Int. Heat Transfer Conf. Paper 19-EN-20, pp. 233–238 (1990).
21. C. Bourillot, TEFERI, Numerical model for calculating the performance of an evaporative cooling tower, EPRI Report CS-3212-SR (1983).

22. M. Poppe and H. Rögener, Evaporative cooling systems, *VDI-Wärmeatlas* (1984).
23. F. Bosnjakovic, *Technical Thermodynamics* (Translated by P. L. Blackshear, Jr.). Holt, Rhinehart and Winston, New York (1960).
24. D. Pescod, Effect of turbulence promoters on the performance of plate heat exchangers, *Heat Exchangers: Design and Theory Sourcebook*. McGraw-Hill, New York (1974).